

V670 Series

Electromagnetic Inductive RFID System

V670-H11/H51/H51Q (Compact Antenna)

V670-D13F01/D13F01H/D13F03 (Compact Tag)

V670-CD1D-V1 (Controller)

A Compact Antenna and Compact Tag join the high-speed, long-life V670-series lineup to provide powerful support for improving productivity and traceability.

Ideal for miniature electronic devices, the manufacture and assembly of components for compact cars, and management of components for mounting equipment.

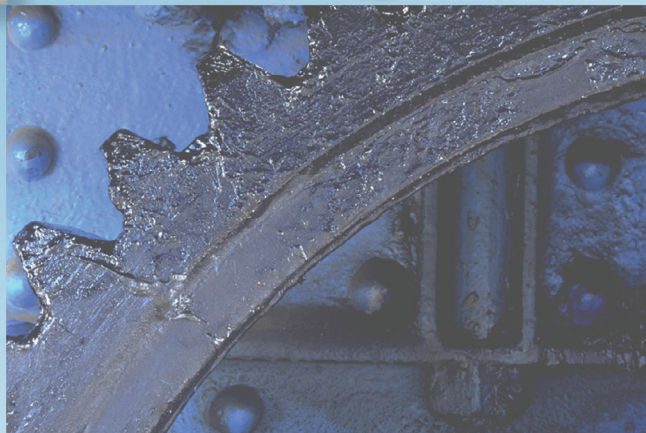

In addition to high-speed processing and long-life memory, the V670 Series now offers space savings, high resistance to the environment, and narrow-pitch mounting. Greater flexibility with mounting location and operating conditions allows use in a much wider range of applications.

Fast

High-speed Processing Comparable to ON/OFF-sensor Operation

The V670 Series performs high-speed data communications with battery-free Tags. Reading and writing of Tag data can be performed at speeds allowing operation that seems like ON/OFF-sensor operation. Even in production lines for small items with short processing times for each process, the communications time does not affect the tact time. It is also now possible to handle more data in processes where, until now, the amount of data has been limited to reduce processing time.

Communications Time

Approx. 5 ms (reading/writing 12 bytes)
Approx. 14 ms (reading/writing 128 bytes)

Reliable Reading and Writing during Operation

A short communications processing time means that data is read and written reliably without stopping the Tags. This means that reading and writing can be performed while Tags and Antennas are moving. Even in cases where Tags are mounted to moving pallets, changes to conveyance control to allow access are unnecessary. Simplified conveyance control contributes to cost reductions in installations.

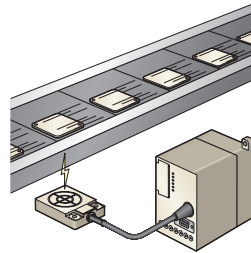

Combination of V670-H51 and V670-D13F01 (Perpendicular Mounting)

Maximum speed: 100 m/min (12 bytes)
Maximum speed: 36 m/min (128 bytes)

Combination of V670-H11 and V670-D13F03

Maximum speed: 360 m/min (12 bytes)
Maximum speed: 150 m/min (128 bytes)

* The speeds given above are the maximum movement speeds in good conditions. When designing the system, give consideration to the actual installation conditions. Also, be sure to thoroughly evaluate the operating environment before use.

Easy

Compact and Slim

The Compact Tags boast streamlined dimensions of 8 x 16 x t3.5 mm (V670-D13F01). Tags both with and without mounting holes are available to suit the application. Also, the mounting direction of the Tags can be changed to allow, for example, mounting on the top of narrow pallets or on the side of slim pallets. Using the V670-A81 Attachment makes it possible to mount Tags on metal surfaces. The Compact Antenna boasts dimensions of M18 x 43 mm (V670-H51). The Antenna is mounted with the screws of the Controller and so fine adjustment of the communications distance can be performed with ease.

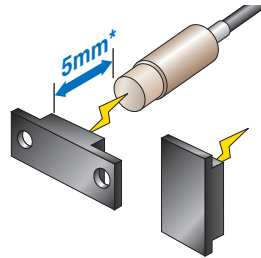

* Without using the Extension Cable for the V670-H51 Antenna.

Narrow-pitch Mounting

The V670 Series uses a communications method with minimal mutual interference and so operation is possible with Tags and Antennas separated only by small gaps; miniature pallets carrying Tags, for example, can be used back-to-back. In assembly lines for miniature devices with small gaps between processes, the system can be installed without worrying about mutual interference between Antennas for neighboring processes.

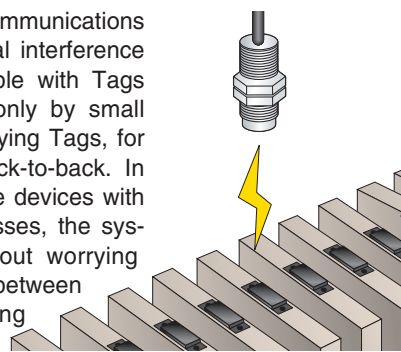

Tag



Antenna

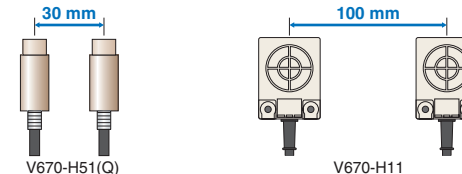

Tough

High Resistance to the Environment

The Tags and Antennas all conform to the IP67 (IEC) degree of protection. In particular, the Compact Antenna (V670-H51Q) uses a fluororesin case, and also conforms to IP67g (JEM; water resistance and oil resistance). PPS resin, which is high in chemical resistance, is used in the case material for the Compact Tag (V670-D13F01/D13F01H) enabling use in harsh environments subject to chemicals, oils, and coolants.

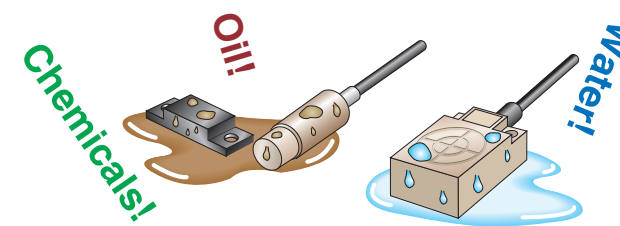

Efficient

Reduced Maintenance with No Battery or Tag Replacement

The V670 Series uses a FeRAM (ferroelectric RAM) with a service life of 1,000 million times and so there is essentially no restriction on the memory service life. Even if the memory were accessed once a second, 24 hours a day, 365 days a year, it would still last more than 10 years. In production lines for miniature devices where pallets are reused with a high frequency, or in applications where data is frequently rewritten, maintenance such as battery replacement or Tag replacement is unnecessary.



*FeRAM: Ferroelectric RAM

Versatile

Communications Control with a Broad Range of Functions

V670-series products are equipped with a wide variety of communications functions that allow host devices to easily perform communications control for the Tags. Using the auto repeat and repeat input trigger functions, repeated communications with several Tags can be performed automatically with a single command. Using the tag specification function, in cases where data is written to individual Tags or where more complex commands are used, such as applications where writing is performed after reading, consideration of the timing with which Tags enter the communications range is not required.

Auto Repeat Function

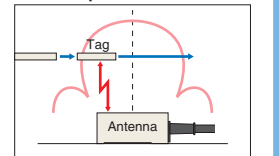

Communications are performed whenever a Tag enters the communications range. Communications are performed only once with the same Tag.

Tag Specification

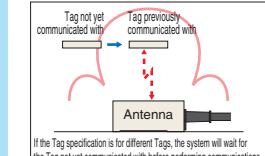

The V670 communicates only with the Tags that it communicated with previously or with the other Tags, depending on the specification.

Repeat Input Trigger

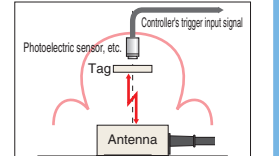

Each time the rising edge of the input signal is detected, the existence of a Tag is confirmed and communications are performed. If there is no Tag, an error is generated.

Simple Control and High-speed Response Achieved with Self-execution Mode

In self-execution mode, the V670 repeats communications according to previously set conditions, discriminates data, and turns ON output accordingly. Control for simple sorting can be performed just using the Controller, without connecting a host device. The time required for exchanging commands and responses is eliminated, enabling the time from communications to result output to be significantly reduced. This makes it possible to perform control for lines and installations requiring high-speed responsiveness.

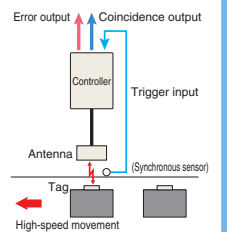

Self-execution System

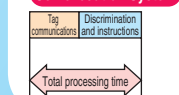

Previous System

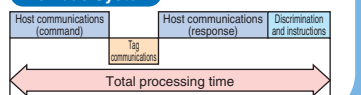

Applications

Line Processing Instructions and Quality History Management

- Processes where processing is performed without stopping
- Production lines with a short tact time
- Lines performing high-mix, high-volume production

Machine Control

- Control of installations performing high-speed processing
- Control of conveyance installations

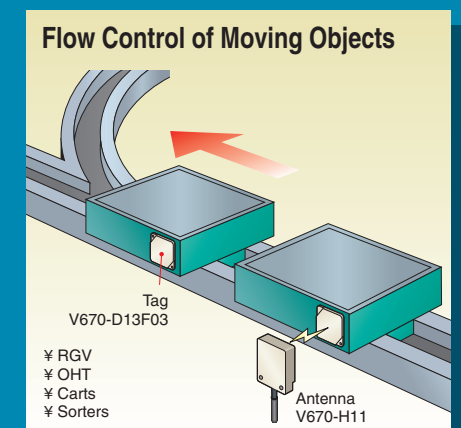
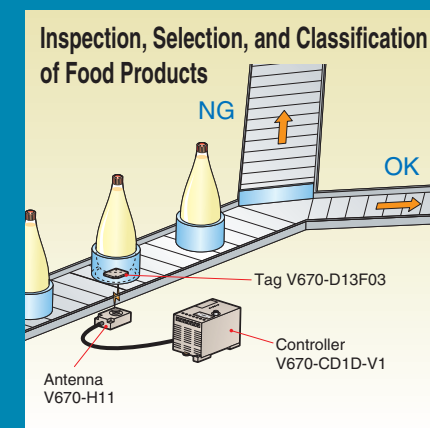
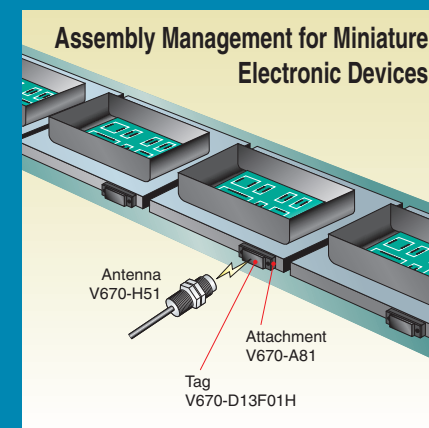
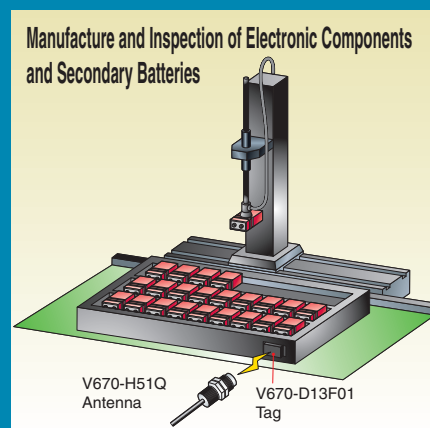
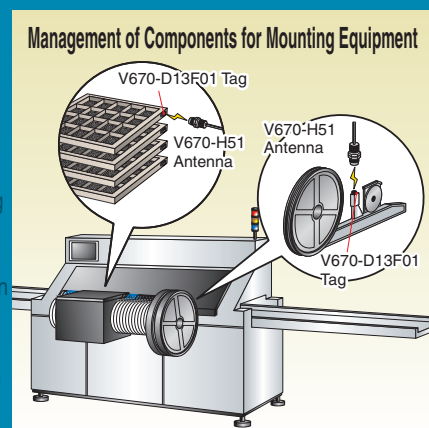

Electromagnetic Inductive RFID System V670







High-speed, Long-life, Battery-less RFID System



- High-speed communications requiring only 14 ms to read or write 128 bytes of data.
- Long-life battery-free tags to read and write data 1,000 million times.
- Versatile functions, such as auto repeat, repeat input trigger, and tag specification.
- Self-execution mode for data processing with no host controller intervention.
- CE marking/FCC approvals.



Ordering Information

■ List of Models

Product	Model		Shape/Specification	
ID Tag	V670-D13F03		40 × 40 × 4.5 mm	128 bytes
	V670-D13F01		8 × 16 × 3.5 mm	
	V670-D13F01H		8 × 28 × 3.5 mm 3.2 dia. mounting holes	
Antenna	V670-H11		40 × 53 × 23 mm	2-m cable Length can be extended with a special Antenna Extension Cable.
	V670-H51 (See note.)		M18 × 43 mm	
	V670-H51Q (See note.)		M18 × 47 mm Chemical-resistant	
Controller	V670-CD1D-V1		90 × 66 × 75 mm	RS-232C interface operating at 24 VDC with a single antenna connector Supports the V670-H51/H51Q
Antenna Extension Cables	V670-A40		3 m	Material: Polyvinyl chloride Connectors are not watertight.
	V670-A41		10 m	
	V670-A42		18 m	
	V670-A43		28 m	
Attachment	V670-A81		8 × 28 × 6 mm 3.2 dia. mounting holes	To mount the V670-D13F01H to metal surfaces

Product	Model		Shape/Specification
Programming Console	C200H-PRO27-E		Operation monitor, set value display, communications, test communications, and error log functions.
Programming Console Conversion Cable	V700-P10		2 m Connects the V670-CD1D and C200H-PRO27-E.

Note: The V670-CD1D cannot be used. Be sure to use the V670-CD1D-V1.

Specifications

■ ID Tags

Item	V670-D13F01	V670-D13F01H	V670-D13F03
Memory capacity	128 bytes		
Memory type	FeRAM		
Memory life	Number of accesses: 1,000 million times (See note.)		
Data storage time	10 years (after the data is written or read)		
Ambient temperature	Operating: -10 to 70°C		
Ambient temperature	Storage: -10 to 70°C		
Ambient humidity	Operating: 35% to 95%		Operating: 35% to 85%
Degree of protection	IEC 60529 IP67		
Vibration resistance	10 to 2,000 Hz, 1.5-mm double amplitude at 150 m/s ² acceleration with 10 sweeps in X, Y, and Z directions for 15 minutes each		
Shock resistance	500 m/s ² in X, Y, and Z directions 3 times each (18 times in total)		
Material	PPS, filled with Epoxy resin		ABS, filled with epoxy resin
Weight	Approx. 1 g	Approx. 1 g	Approx. 6 g

Note: The number of accesses is the total number of read or write communications.

■ Antenna

Item	V670-H51	V670-H51Q	V670-H11
Oscillation frequency	13.56 MHz		
Ambient temperature	Operating: -10 to 70°C		
Ambient temperature	Storage: -25 to 75°C		Storage: -25 to 85°C
Ambient humidity	Storage: 35% to 95%		Storage: 35% to 85%
Insulation resistance	20 MΩ min.		
Dielectric strength	1,000 VAC for 1 minute between the terminals and case with a current leakage of 5 mA		
Degree of protection	IEC 60529 IP67 (See note 1.)	IEC 60529 IP67 IP67g (transmission surface only, JEM standard) (See note 1.)	IEC 60529 IP67 (See note 1.)
Vibration resistance	10 to 500 Hz, 1.5-mm double amplitude at 100 m/s ² acceleration with 10 sweeps in X, Y, and Z directions for 11 minutes each		10 to 150 Hz, 0.7-mm double amplitude at 50 m/s ² acceleration with 10 sweeps in X, Y, and Z directions for 8 minutes each
Shock resistance	300 m/s ² in X, Y, and Z directions 3 times each (18 times in total)		
Material	PBT/brass, filled with epoxy resin	Fluororesin, filled with epoxy resin	ABS, filled with epoxy resin
Cable length	2 m (total length: 30 m (See note 2.))		
Tightening torque	70 N·m	2 N·m	---
Approved standards	FCC/R&TTE (CE)		
Weight	140 g	130 g	Approx. 160 g

Note: 1. The connector is not watertight.

2. The communications distance will be reduced if the cable is extended. The communications distance also depends on the type of extension cable used. Refer to *Transmission Distance Specifications* for details.

■ Controller

Item	V670-CD1D-V1 (See note.)
Host interface specifications	RS-232C
Number of connectable antennas	1
Power supply voltage	24 VDC ±10%
Power consumption	7 W max.
Ambient temperature	Operating: 0 to 55°C (with no icing)
Ambient humidity	Operating: 35% to 85% (with no condensation)
Ambient temperature	Storage: -20 to 75°C (with no icing)
Insulation resistance	20 MΩ min.
Dielectric strength	1,000 VAC for 1 minute in all the above combinations with a maximum leakage current of 20 mA
Degree of protection	Panel mounted
Vibration resistance	10 to 150 Hz, 0.2-mm double amplitude at 15 m/s ² acceleration with 10 sweeps in X, Y, and Z directions for 8 minutes each.
Shock resistance	15 m/s ² in X, Y, and Z directions 3 times each (18 times in total)
Ground	Ground at a resistance of less than 100 Ω
Materials	PC/ASA resin
Approved standards	FCC/R&TTE (CE)
Weight	Approx. 270 g

Note: The V670-CD1D-V1 must be used when using the V670-H51/H51Q. The V670-CD1D cannot be used.



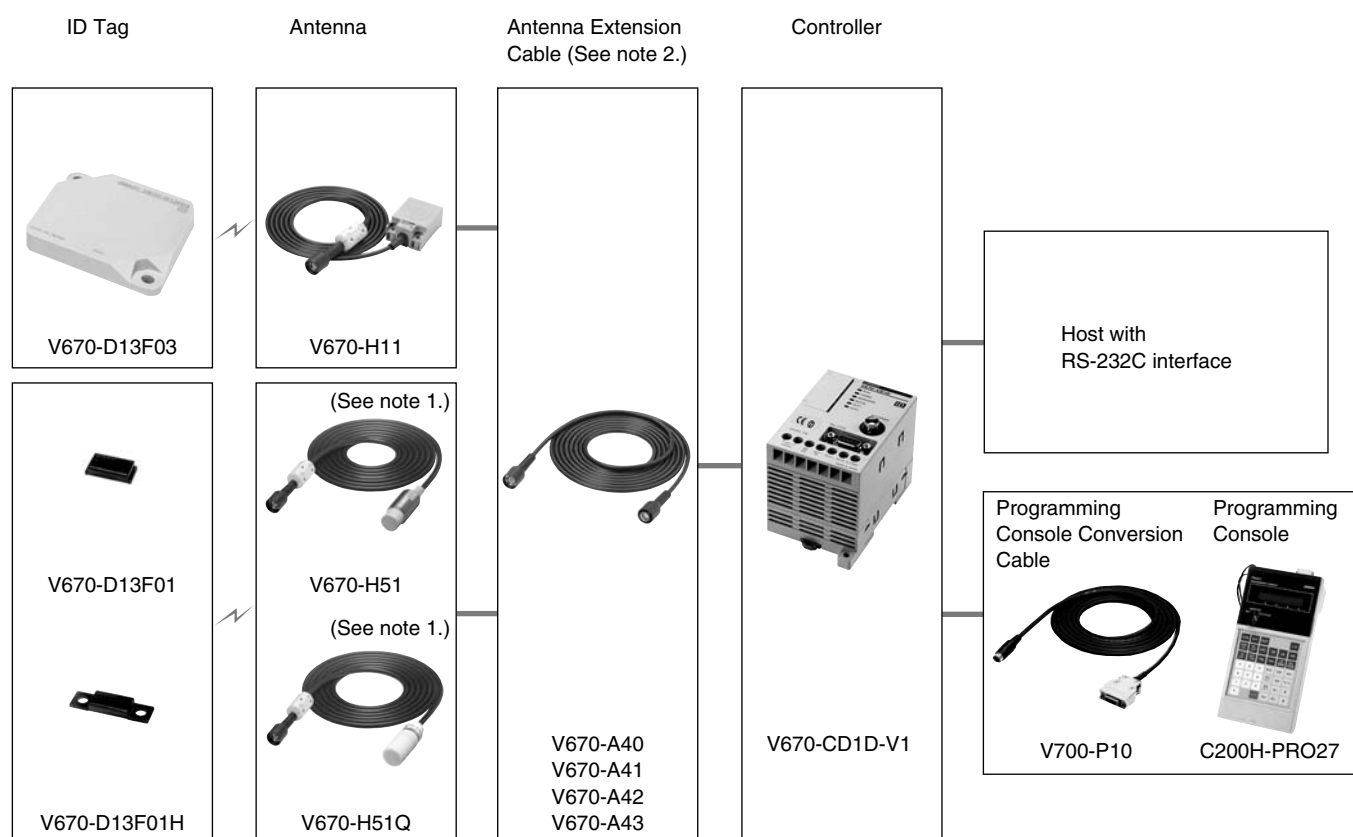



System Configuration

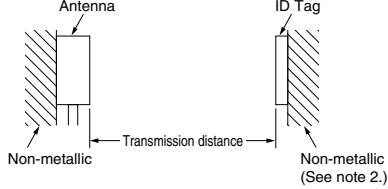
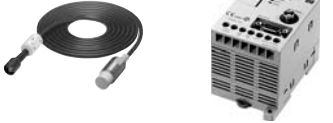

Note: 1. The V670-CD1D-V1 must be used when using the V670-H51/H51Q. The V670-CD1D cannot be used.

2. When extending the antenna cable, do not use any cable other than the Antenna Extension Cables from OMRON.

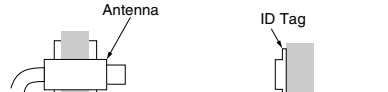
■ Transmission Distance Specifications

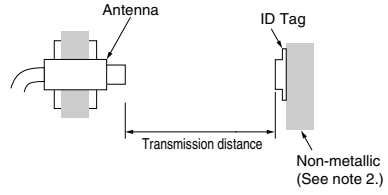
Antenna/Controller	ID Tag	Transmission distance		Measurement conditions	
		Without Extension Cable	With Extension Cable		
V670-H11 + V670-CD1D-V1 	V670-D13F03 	5.0 to 23.0 (axial offset: ±1)	A40 (3 m)	5.0 to 21.5	
			A41 (10 m)	5.0 to 21.0	
			A42 (18 m)	5.0 to 20.5	
			A43 (28 m)	5.0 to 20.0	
V670-H51 + V670-CD1D-V1 	V670-D13F01 	0.5 to 5.0 (axial offset: ±1)	A40 (3 m)	0.5 to 5.0	
			A41 (10 m)	0.5 to 4.0	
			A42 (18 m)		
			A43 (28 m)		
V670-H51Q + V670-CD1D-V1 	V670-D13F01H 	0.5 to 4.5 (axial offset: ±1)	A40 (3 m)	0.5 to 4.5	
			A41 (10 m)	0.5 to 3.5	
			A42 (18 m)		
			A43 (28 m)		

Note: 1. The transmission distance is reduced if an Extension Cable is used. Also, the transmission distance varies with the type of Extension Cable.

2. When the background object of the antenna is metal, the communications area is almost the same. If the tag is attached on metal without a gap, no communications will be possible. For details, refer to the *V670 User's Manual (Z148-E1)*.

Characteristic Data (Typical)

■ Transmission Range (Condition: No Extension Cable)

Combination of V670-H11 and V670-D13F03

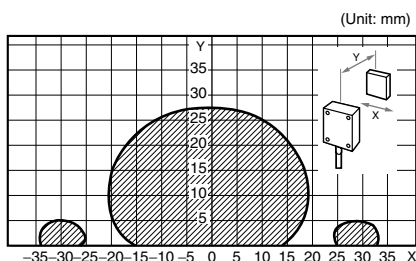

Combination of V670-H51 and V670-D13F01(H) when Mounted Vertically to Movement

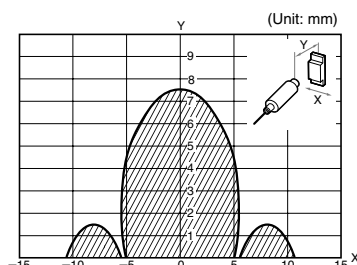

Combination of V670-H51 and V670-D13F01(H) when Mounted Horizontally to Movement

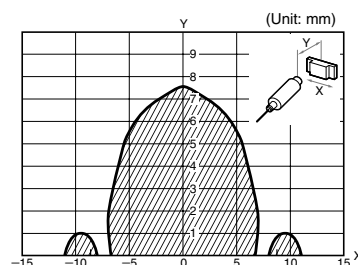

Combination of V670-H51Q and V670-D13F01(H) when Mounted Vertically to Movement

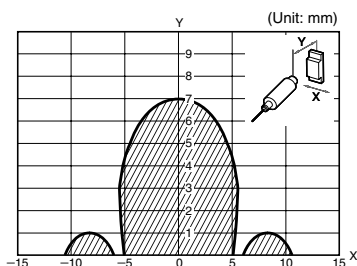

Combination of V670-H51Q and V670-D13F01(H) when Mounted Horizontally to Movement

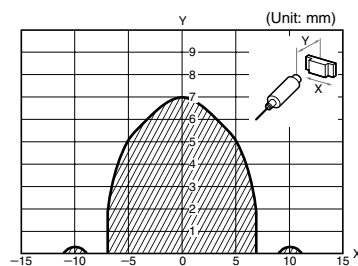

■ Transmission Time (Reference)

Communications time is a period required for communications between the antenna and ID Tag.

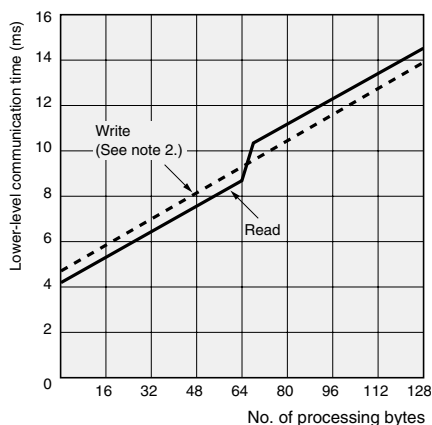

Operation	No. of bytes	Calculation formula
Read	1 to 64 bytes	$T = 0.07 \times N + 4.22$
	65 to 128 bytes	$T = 0.07 \times N + 5.64$
Write	1 to 128 bytes	$T = 0.07 \times N + 4.72$

Note: 1. N: Number of bytes
T: Communications time (ms)

2. The write data is for when the verify and write-protect functions are not used.

■ Movement Speed (Reference)

Tag movement speed must be a maximum of 50% of the maximum movement speed according to the number of processing bytes to ensure the reliability of communications. Conduct proper on-site tests to determine the tag movement speed. (The following data applies only if an Extension Cable is not used.)

Combination of V670-H11 and V670-D13F03

Read

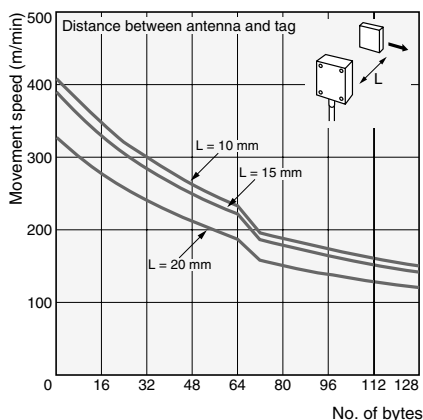

Write (See note.)

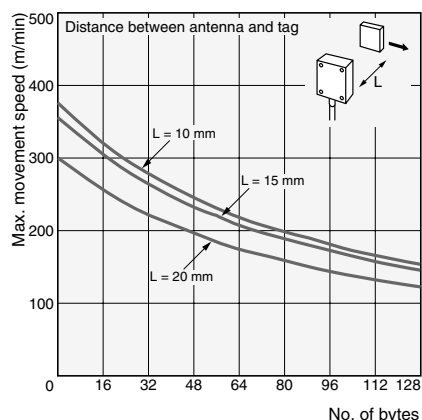

Combination of V670-H51(Q) and V670-D13F01(H)

Read when Mounted Vertically to Movement

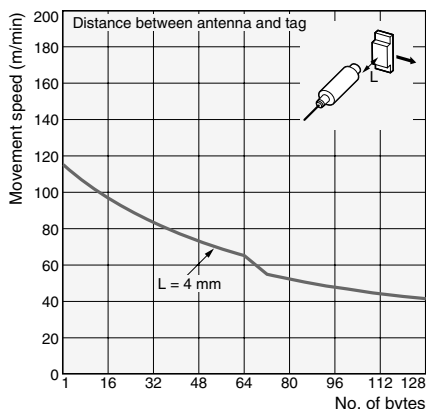

Write when Mounted Vertically to Movement (See note.)

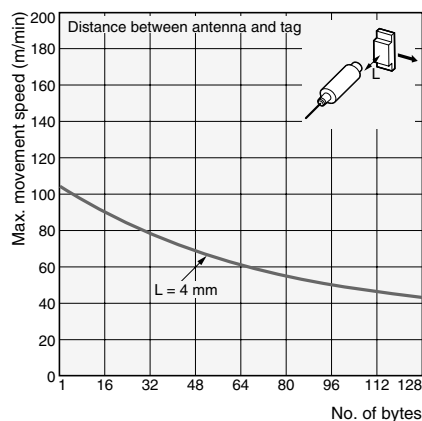

Read when Mounted Horizontally to Movement

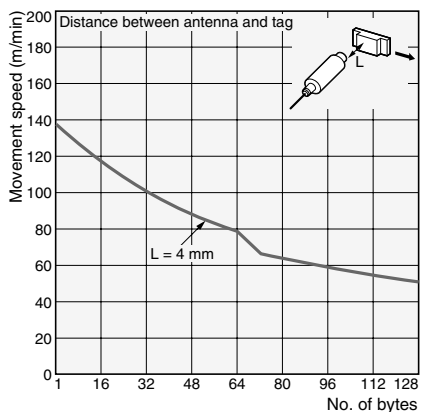

Write when Mounted Horizontally to Movement (See note.)

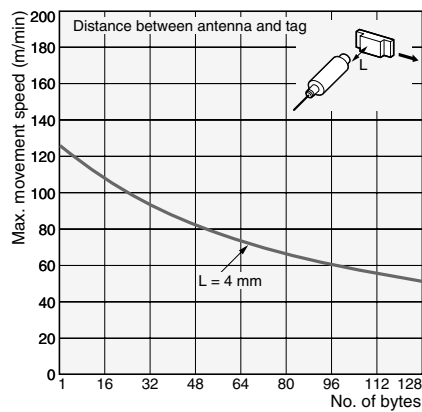

Note: The write data is for when the verify and write-protect functions are not used.

Dimensions

Note: All units are in millimeters unless otherwise indicated.

ID Tag

V670-D13F01

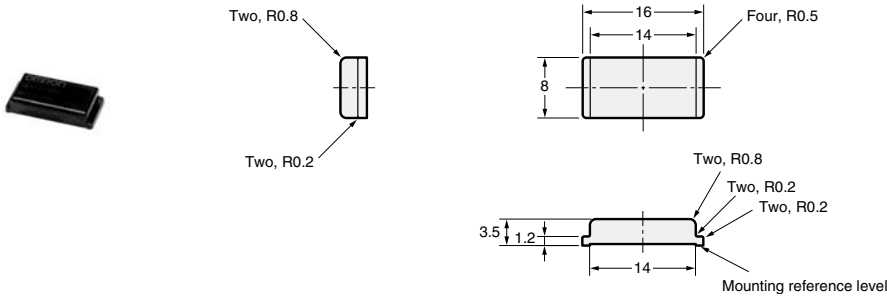

Case material: PPS resin
 Filler: Epoxy resin

V670-D13F01H

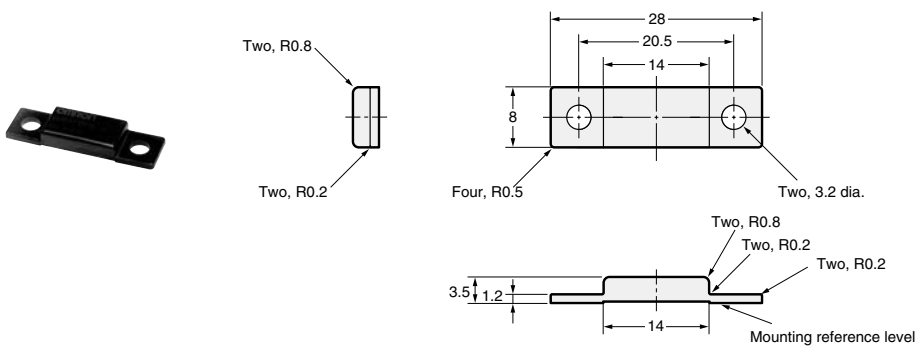

Mounting Hole Dimensions

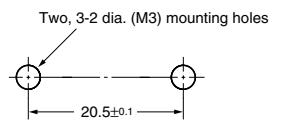

Case material: PPS resin
 Filler: Epoxy resin

V670-D13F03

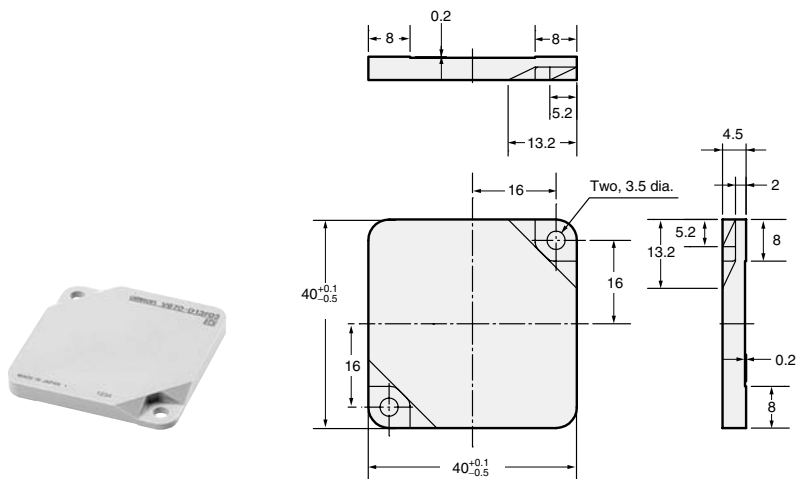

Mounting Hole Dimensions

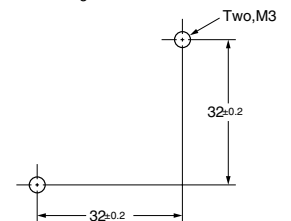

Case material: ABS resin
 Filler: Epoxy resin

Controller

V670-CD1D-V1

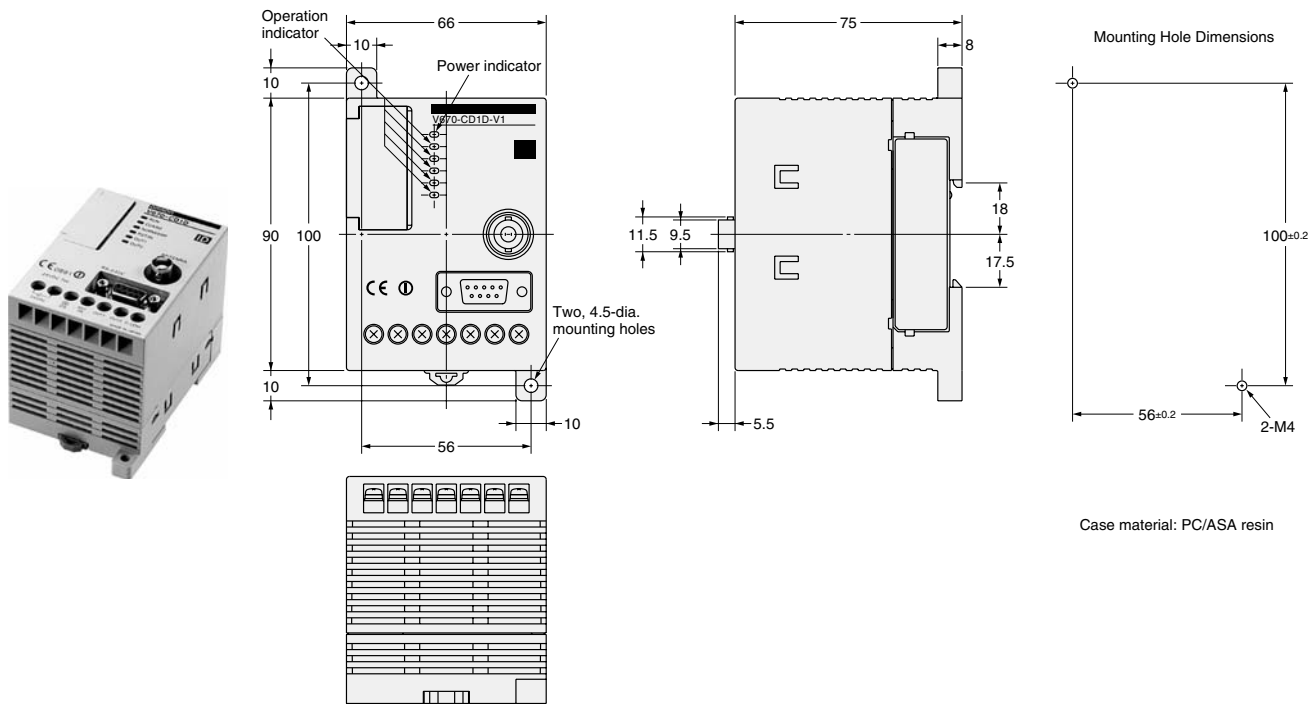

Extension Cable

V670-A40/A41/A42/A43

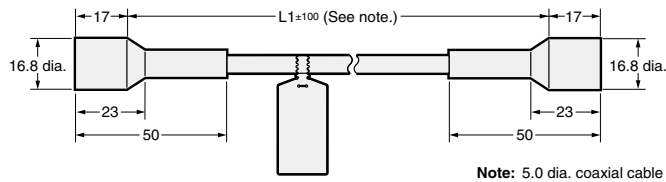

Model	Length
V670-A40	3 m
V670-A41	10 m
V670-A42	18 m
V670-A43	28 m

Attachment

V670-A81

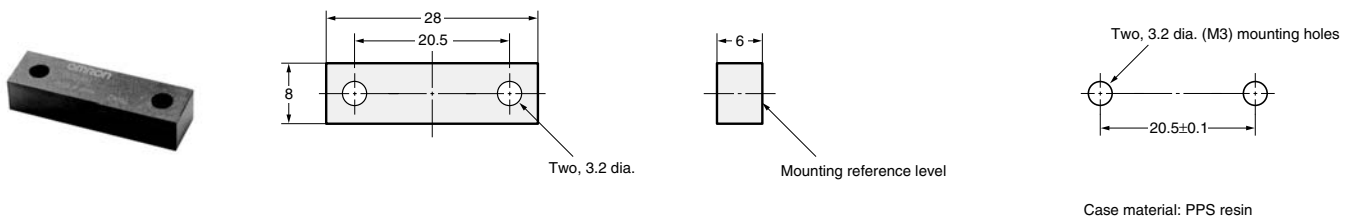

ALL DIMENSIONS SHOWN ARE IN MILLIMETERS.
To convert millimeters into inches, multiply by 0.03937. To convert grams into ounces, multiply by 0.03527.

READ AND UNDERSTAND THIS DOCUMENT

Please read and understand this document before using the products. Please consult your OMRON representative if you have any questions or comments.

WARRANTY

OMRON's exclusive warranty is that the products are free from defects in materials and workmanship for a period of one year (or other period if specified) from date of sale by OMRON.

OMRON MAKES NO WARRANTY OR REPRESENTATION, EXPRESS OR IMPLIED, REGARDING NON-INFRINGEMENT, MERCHANTABILITY, OR FITNESS FOR PARTICULAR PURPOSE OF THE PRODUCTS. ANY BUYER OR USER ACKNOWLEDGES THAT THE BUYER OR USER ALONE HAS DETERMINED THAT THE PRODUCTS WILL SUITABLY MEET THE REQUIREMENTS OF THEIR INTENDED USE. OMRON DISCLAIMS ALL OTHER WARRANTIES, EXPRESS OR IMPLIED.

LIMITATIONS OF LIABILITY

OMRON SHALL NOT BE RESPONSIBLE FOR SPECIAL, INDIRECT, OR CONSEQUENTIAL DAMAGES, LOSS OF PROFITS OR COMMERCIAL LOSS IN ANY WAY CONNECTED WITH THE PRODUCTS, WHETHER SUCH CLAIM IS BASED ON CONTRACT, WARRANTY, NEGLIGENCE, OR STRICT LIABILITY.

In no event shall responsibility of OMRON for any act exceed the individual price of the product on which liability is asserted.

IN NO EVENT SHALL OMRON BE RESPONSIBLE FOR WARRANTY, REPAIR, OR OTHER CLAIMS REGARDING THE PRODUCTS UNLESS OMRON'S ANALYSIS CONFIRMS THAT THE PRODUCTS WERE PROPERLY HANDLED, STORED, INSTALLED, AND MAINTAINED AND NOT SUBJECT TO CONTAMINATION, ABUSE, MISUSE, OR INAPPROPRIATE MODIFICATION OR REPAIR.

SUITABILITY FOR USE

THE PRODUCTS CONTAINED IN THIS DOCUMENT ARE NOT SAFETY RATED. THEY ARE NOT DESIGNED OR RATED FOR ENSURING SAFETY OF PERSONS, AND SHOULD NOT BE RELIED UPON AS A SAFETY COMPONENT OR PROTECTIVE DEVICE FOR SUCH PURPOSES. Please refer to separate catalogs for OMRON's safety rated products.

OMRON shall not be responsible for conformity with any standards, codes, or regulations that apply to the combination of products in the customer's application or use of the product.

At the customer's request, OMRON will provide applicable third party certification documents identifying ratings and limitations of use that apply to the products. This information by itself is not sufficient for a complete determination of the suitability of the products in combination with the end product, machine, system, or other application or use.

The following are some examples of applications for which particular attention must be given. This is not intended to be an exhaustive list of all possible uses of the products, nor is it intended to imply that the uses listed may be suitable for the products:

- Outdoor use, uses involving potential chemical contamination or electrical interference, or conditions or uses not described in this document.
- Nuclear energy control systems, combustion systems, railroad systems, aviation systems, medical equipment, amusement machines, vehicles, safety equipment, and installations subject to separate industry or government regulations.
- Systems, machines, and equipment that could present a risk to life or property.

Please know and observe all prohibitions of use applicable to the products.

NEVER USE THE PRODUCTS FOR AN APPLICATION INVOLVING SERIOUS RISK TO LIFE OR PROPERTY WITHOUT ENSURING THAT THE SYSTEM AS A WHOLE HAS BEEN DESIGNED TO ADDRESS THE RISKS, AND THAT THE OMRON PRODUCT IS PROPERLY RATED AND INSTALLED FOR THE INTENDED USE WITHIN THE OVERALL EQUIPMENT OR SYSTEM.

PERFORMANCE DATA

Performance data given in this document is provided as a guide for the user in determining suitability and does not constitute a warranty. It may represent the result of OMRON's test conditions, and the users must correlate it to actual application requirements. Actual performance is subject to the OMRON Warranty and Limitations of Liability.

CHANGE IN SPECIFICATIONS

Product specifications and accessories may be changed at any time based on improvements and other reasons.

It is our practice to change model numbers when published ratings or features are changed, or when significant construction changes are made. However, some specifications of the product may be changed without any notice. When in doubt, special model numbers may be assigned to fix or establish key specifications for your application on your request. Please consult with your OMRON representative at any time to confirm actual specifications of purchased products.

DIMENSIONS AND WEIGHTS

Dimensions and weights are nominal and are not to be used for manufacturing purposes, even when tolerances are shown.

ERRORS AND OMISSIONS

The information in this document has been carefully checked and is believed to be accurate; however, no responsibility is assumed for clerical, typographical, or proofreading errors, or omissions.

PROGRAMMABLE PRODUCTS

OMRON shall not be responsible for the user's programming of a programmable product, or any consequence thereof.

COPYRIGHT AND COPY PERMISSION

This document shall not be copied for sales or promotions without permission.

This document is protected by copyright and is intended solely for use in conjunction with the product. Please notify us before copying or reproducing this document in any manner, for any other purpose. If copying or transmitting this document to another, please copy or transmit it in its entirety.

Cat. No. Q128-E1-04A

In the interest of product improvement, specifications are subject to change without notice.

OMRON Corporation
Industrial Automation Company

Sensing Devices Division H.Q.
Industrial Sensors Division
 Shiokoji Horikawa, Shimogyo-ku,
 Kyoto, 600-8530 Japan
 Tel: (81)75-344-7022/Fax: (81)75-344-7107

Regional Headquarters

OMRON EUROPE B.V.
 Sensor Business Unit,
 Carl-Benz-Str. 4, D-71154 Nufringen,
 Germany
 Tel: (49)7032-811-0/Fax: (49)7032-811-199

OMRON ELECTRONICS LLC
 1 East Commerce Drive, Schaumburg,
 IL 60173 U.S.A.
 Tel: (1)847-843-7900/Fax: (1)847-843-8568

OMRON ASIA PACIFIC PTE. LTD.

83 Clemenceau Avenue,
 #11-01, UE Square,
 239920 Singapore
 Tel: (65)6835-3011/Fax: (65)6835-2711

OMRON CHINA CO., LTD.

Room 2211, Bank of China Tower,
 200 Yin Cheng Road (M),
 Shanghai, 200120 China
 Tel: (86)21-5037-2222/
 Fax: (86)21-5037-2200

Printed in Japan
 0906-0.3M (C)